

IVECO

Drive the road of change



IVECO  S-WAY

 S-WAY

Overseas Model Shown



IVECO S-WAY

The latest in safety, efficiency, comfort and performance

The highly awarded new IVECO S-WAY is now available in Australia and New Zealand.

Featuring the latest in Euro 6 (Step E) emission performance, advanced safety technologies, powerful engines and multiple configuration choices to help boost productivity, S-WAY is an ideal heavy-duty truck for owner-drivers through to major fleet operators.

Debuting a visually stunning new cabin design that combines functionality and aesthetics, and available in rigid and prime mover variants, with multiple wheelbases, cab sizes and GVM options, S-WAY is perfect for a broad range of general freight and specialist heavy-duty applications.

Style meets performance...

A stunning new cabin design that optimises aerodynamic performance for added fuel efficiency, while combining new features that add convenience and functionality.

The benefits continue under the skin with a dynamic driveline that will boost productivity. The new Cursor engine range is IVECO's most efficient ever delivering impressive Euro 6 Step E emission performance with generous power and torque output – it's the perfect partner to the market-leading Hi-Tronix Automated Manual Transmissions (AMTs).

OPTIMISED MIRROR DESIGN

REDESIGNED DOOR AND EXTENSION

ADVANCED NEW CURSOR ENGINE LINE-UP

POWERFUL YET EFFICIENT EURO 6 (STEP E) ENGINES



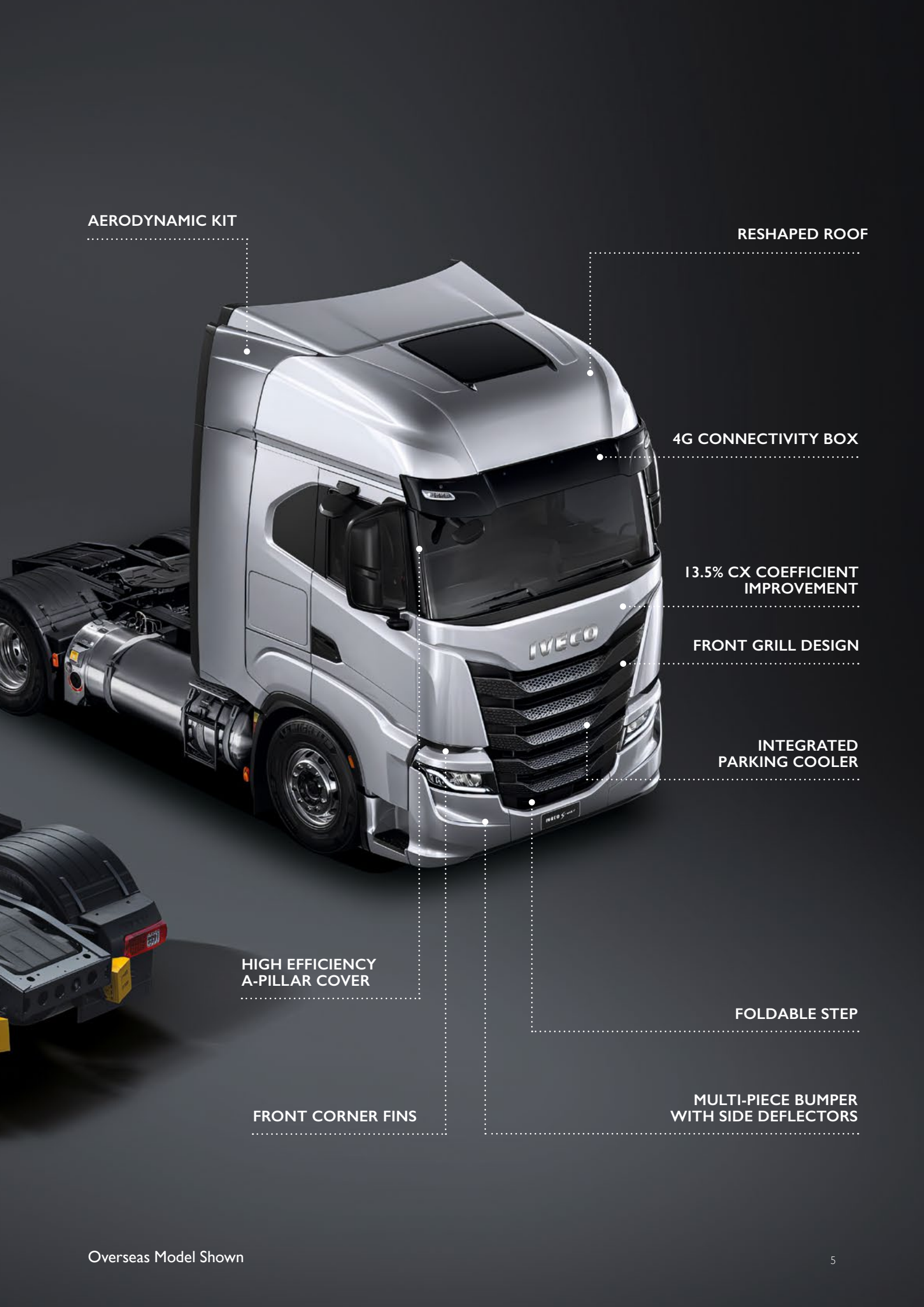

AERODYNAMIC KIT

RESHAPED ROOF

4G CONNECTIVITY BOX

13.5% CX COEFFICIENT
IMPROVEMENT

FRONT GRILL DESIGN

INTEGRATED
PARKING COOLER

HIGH EFFICIENCY
A-PILLAR COVER

FOLDABLE STEP

FRONT CORNER FINIS

MULTI-PIECE BUMPER
WITH SIDE DEFLECTORS

High-Efficiency engines

Power for the S-WAY range comes courtesy of three powerful yet fuel-efficient engines, the Cursor 9, Cursor 11 and Cursor 13 – two states of tune are available for Cursor 13 variants, providing buyers with four output choices.

All powerplants meet stringent Euro6 (Step E) emission requirements – Step E places more severe limits on engine cold start performance. All engines are also fully compatible with second generation biofuels HVO/XTL (EN15940)*.

The engine range begins with the 8.7l Cursor 9 which produces 360hp from 1,530 to 2,200 rpm and 1,650Nm from 1,200 to 1,530rpm. In the 11.1l Cursor 11, power jumps to 460hp from 1,500 to 1,900rpm and 2150Nm of torque from 925 to 1,500rpm.

The largest of the engine family is the 12.9l Cursor 13 which starts with output of 530hp at between 1,600 to 1,900rpm and torque of 2,400Nm from 950 to 1,500rpm. A second Cursor 13 rating sees it produce 550hp from 1,605 to 1,900rpm with torque of 2,500Nm from 1,000 to 1,605rpm.

All engines use IVECO's patented and proven HI-eSCR emission control technology. HI-eSCR is a single after-treatment system featuring passive DPF (Diesel Particulate Filter) – DPF regeneration does not require driver intervention.

*Synthetically produced paraffinic diesel fuel.

Diesel Engine Line-up

| Engine | Displacement (Litres) | Power | | | Torque | | Turbo | Cab Type | |
|-----------|-----------------------|-------|-----|-----------|--------|-----------|-------|----------|-------|
| | | hp | kW | rpm | Nm | rpm | | AS | AT/AD |
| Cursor 9 | 8.7 | 360 | 265 | 1530-2200 | 1650 | 1200-1530 | WG | - | • |
| Cursor 11 | 11.1 | 460 | 338 | 1500-1900 | 2150 | 925-1500 | eVGT | • | • |
| Cursor 13 | 12.9 | 530 | 387 | 1600-1900 | 2400 | 950-1500 | eVGT | • | - |
| | | 550 | 419 | 1605-1900 | 2500 | 1000-1605 | eVGT | • | - |



Cursor 9



Cursor 11



Cursor 13

Fuel saving technologies – better for the environment and the bottom line

All S-WAY models benefit from technologies that cut emissions while helping to boost the operator's profitability. An engine anti-idling function automatically shuts off the engines after a predetermined period to avoid wasting fuel; the system can be disabled or adjusted to suit the application if required.

S-WAY also features 'ECO-SWITCH', which allows the driver to transition between 'ECO-FLEET' and normal operation. ECO-FLEET essentially maintains the Hi-Tronix transmission in automatic mode, allowing the transmission to operate in the optimal gear and within a torque curb that returns the best fuel efficiency. If traffic or road conditions temporarily require the driver to manually override the auto mode, they can do so at the press of a button. If ECO-FLEET is activated, the available engine power and torque is limited – the vehicle itself will cleverly estimate the payload via on-board systems depending on the load and will adjust accordingly.

Additional efficiencies are also achieved through 'HI-CRUISE', a GPS-predictive driving system that integrates cruise control and certain automated Hi-Tronix transmission functions, that interact to manage speed control, gear selection and Eco-roll (a feature that disengages the driveline to use vehicle inertia when facing a moderate slope, maintaining kinetic energy for longer) in the most fuel-efficient way.

The system evaluates continually and in real-time considering the road profile in front of the vehicle using GPS, 3D maps and working conditions, taking into account GCW (Gross Combination Weight) and overall drag coefficient. According to these parameters and driver settings, the truck defines the optimal speed and gear (including neutral) to conserve fuel.



Hi-Tronix transmissions – ultimate control and flexibility

Coupled to all engines in the S-WAY range are IVECO's 12 and 16-speed Hi-Tronix automated manual transmissions offering category-leading technology and best-in-class torque to weight ratio.

The Hi-Tronix AMTs are direct drive units that delivers fast gear changes and also have the ability to more efficiently select the correct ratio for the road and load conditions at hand. Additionally, the transmission can achieve an extended life (up to 80 per cent) compared to other AMTs, for durability of up to 1.6 million kilometres leading to lower vehicle cost of ownership.

For greater flexibility across a range of applications, the Hi-Tronix is equipped with 'Rocking' and 'Creeping' modes as well as four reverse gears. When Rocking mode is engaged, the clutch is disengaged by simply releasing the accelerator pedal (the vehicle rolls back) and re-engages when the accelerator is pressed again, to recover traction in slippery conditions.

With Creeping mode selected, the vehicle moves forward at minimum speed simply by releasing the service brake pedal – this is a useful feature allowing for precise, low speed maneuvering. Also aiding maneuverability particularly when coupling or reversing trailers are the unit's four reverse gears, two of which provide the operator with more speed when reversing in open spaces.

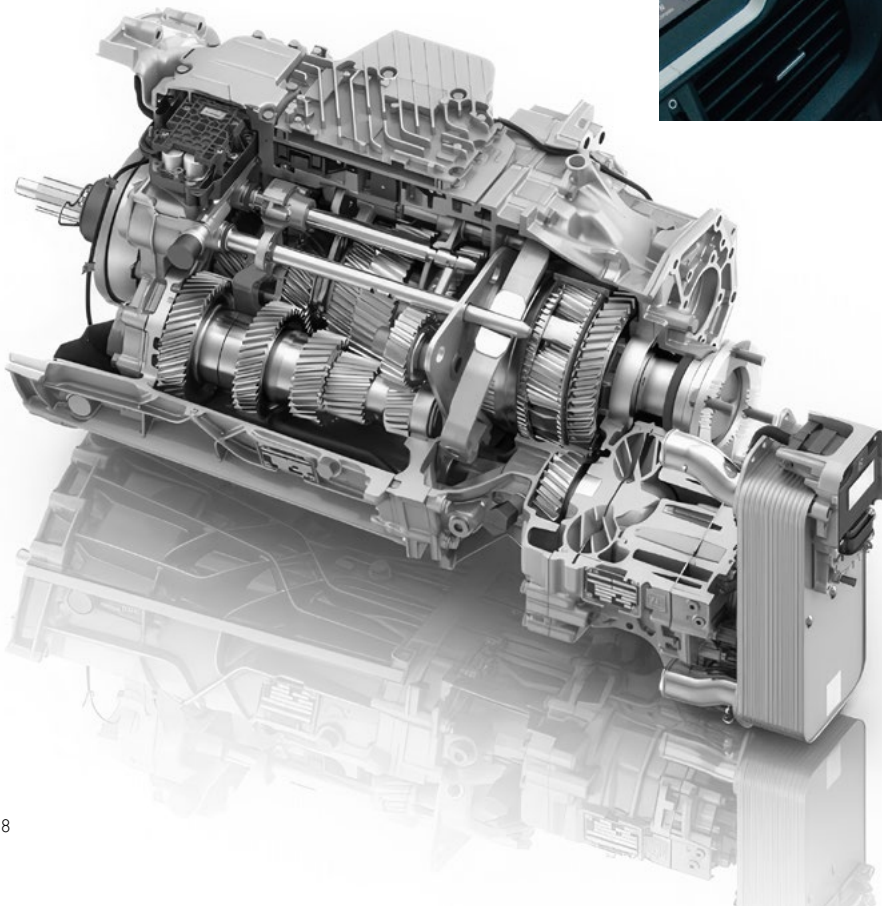

World class active and passive safety

S-WAY features a large range of standard safety equipment. All models feature Advanced Emergency Braking System, Brake Assistance System, Adaptive Cruise Control, Lane Departure Warning System, Electronic Stability Program with ABS (disc brakes all round) and ASR (Anti-Slip Regulation), Hill Holder and Driver Style Evaluation plus Driver Attention Support (DSE + DAS).

DAS checks the driver's level of attention by analysing steering wheel movements. If a state of drowsiness is detected, a message on the screen and an audible signal prompt the driver to stop for a rest. DSE analyses data and provides driving advice in real-time – this is displayed within the instrument cluster or can be accessed on smart phones using the 'My IVECO – Easy Way' app.

New high output full L.E.D headlamps are also standard across the range. The headlamps include integrated DRLs and turn indicator along with fog light and

cornering functionality; they're also automatic using a twilight sensor located on the windscreen. As well as providing a more powerful white light output that more closely resembles natural light and minimises eye fatigue, L.E.Ds have a much longer lifecycle.

S-WAY also introduces even stronger ECE-R29.3 Cab Strength Certification while also meeting ECE-R93 Front Underrun Protection requirements.

Selected models also include a retarder and tyre pressure monitoring system as standard – this equipment can also be specified as an extra cost option for those without. And for additional safety when coupling and decoupling trailers, prime movers are equipped with an extended catwalk.



The latest from Europe – honed for Australia

Prime Mover – An ideal choice for single trailer or B-Double work

S-WAY prime mover models are available in 4x2 and 6x4 configuration and in three cab options: Active Day (AD), Active Time (AT) and the largest of all, Active Space (AS). Additionally, three cab height options are available across the line-up.

There's also a choice of four wheelbases, 3650mm, 3200mm, 3300mm and 3500mm, while GVM and GCMs begin at 18,200kg / 50,000kg, through to 27,600kg / 60,000kg and 27,600kg / 70,000kg for the range topping AS model.

Model dependent, all trucks feature IVECO's proven 12-speed and 16-speed Hi-Tronix Automated Manual Transmissions which offer smooth and efficient power deliver along with long service intervals.

Power in the prime mover line-up comes courtesy of three Euro6 engines with outputs ranging in output from 460hp and 2,150Nm to 550hp and 2,500Nm.

Rigid – Local, intra and interstate delivery has never looked better

Final mile delivery and drops off between capital cities and regional centres and towns can present many challenges for drivers who need to balance tight deadlines, while negotiating a range of different operating situations, from heavy city traffic to poorly maintained country roads.

These conditions require a versatile model range such as the S-WAY rigid, which cleverly combines all the attributes you need in a workhorse, including efficient driveline with low emission performance, advanced safety and superior driver comfort features and ergonomics.

The rigid range includes 6x2, 6x4 and 8x4 (with load share front suspension) configurations and two cab options Active Day (AD) and Active Time (AT); two cabin height options are also available.

Operators can select from 10 wheelbase choices in the rigid line-up – model dependent, these span between 3,500mm to 6050mm, while GVM and GCM choices range from 27,600kg / 41,000kg to 27,600kg / 70,000kg for selected variants (13l 6x4 and 8x4 models).

Like the prime mover, S-WAY rigid models make use of the Cursor engine range and Hi-Tronix Automated Manual Transmission combination – model dependent 12 and 16-speed variants of the Hi-Tronix are available, while engine choice spans from outputs of 360hp and 1,650Nm to 550hp and 2,500Nm.



Premium driving comfort

The new S-WAY further strengthens IVECO's reputation for designing some of the quietest, most comfortable and ergonomically designed interiors available in a commercial vehicle, leading to a more enjoyable and stress-free driving environment.

STEERING WHEEL

Convenient multi-function steering wheel

KEY LOCK AREA

Simple start/stop engine button

INTEGRATED HVAC SYSTEM

Heating, ventilation and air conditioning with "Eco-mode" function



Leather and fabric seating options.*

INFOTAINMENT

High-definition Infotainment system with Apple CarPlay® and smart phone mirroring

TWILIGHT & RAIN SENSOR

Automatically turns on the headlights and wipers

LOWER CONSOLE

Backlit shelf with bottle and cub holders

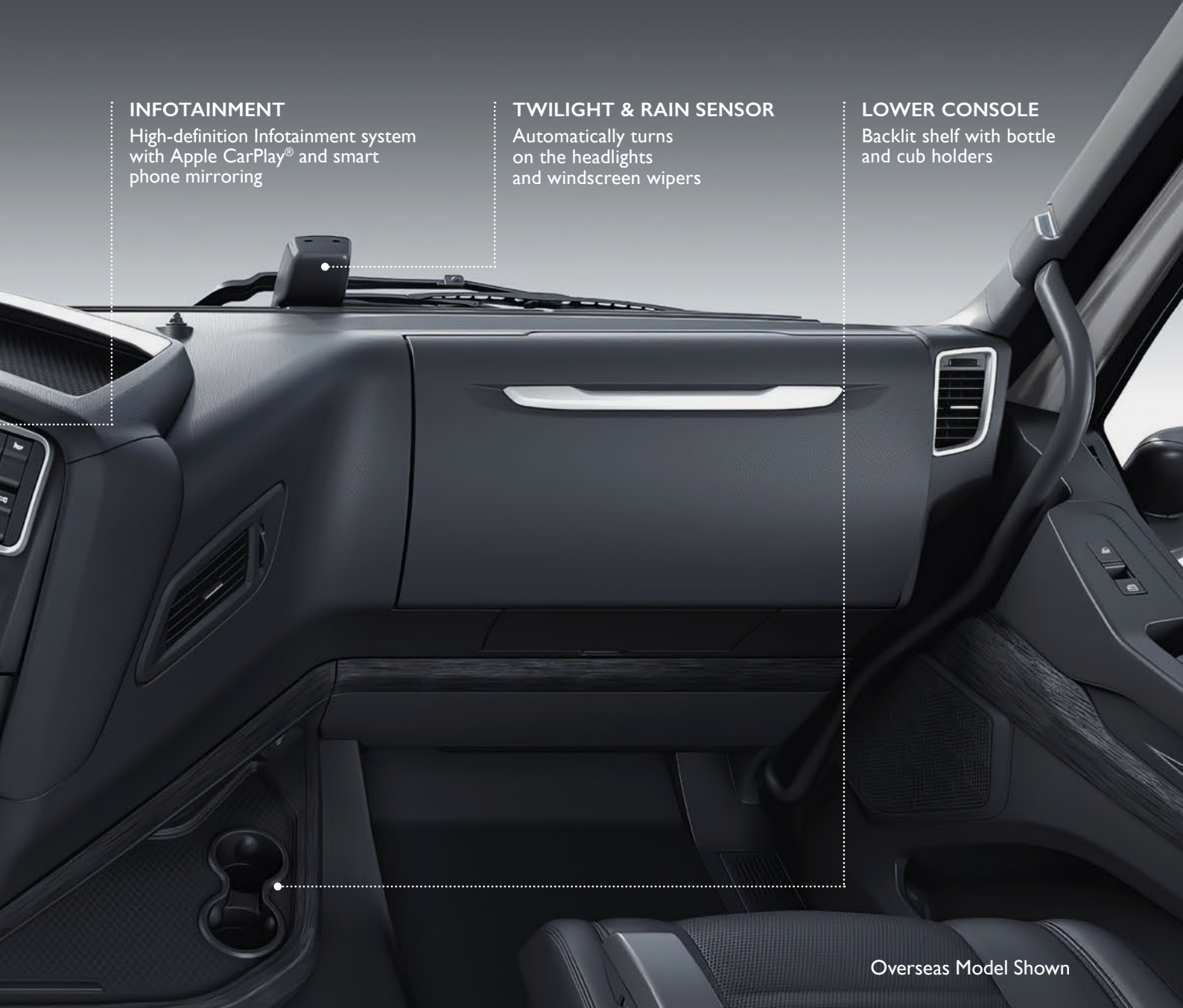

Overseas Model Shown



Select from either soft touch or leather steering wheel, in either classic or flat base shape.*

*Model dependent

...Functionality meets comfort



CHOICE OF UPPER BUNKS

CENTRAL BED MODULE

SYMMETRIC BED ZONE CONCEPT

MULTIPLE FRIDGE COMBINATIONS

CONVENIENT WALL POCKETS



FULL LED INTERIOR LIGHTING

LARGE ROOF HATCH

SHAPED HIGH-CAPACITY UPPER SHELF

NEW IVECO
DRIVER PAL

EASY-TO-REACH
ROOF POCKETS

CHOICE OF SEAT
UPHOLSTERY
AND FEATURES

MORE SPACE
FOR THE DRIVER

MULTI-FUNCTIONAL
STEERING WHEEL

ELECTRONIC KEY SLOT
AND ENGINE START/STOP BUTTON

LOWER CENTRAL CONSOLE
AND REDESIGNED CENTRAL STACK

COMFORTABLE 2.15M STANDING HEIGHT
IN AS CAB

Everything in its place

The spacious new cab offers all the storage you need, with well laid-out capacious compartments. The shaped upper shelf has a massive capacity of 250 litres.



The outer compartments offer a massive storage capacity of up to 380 litres.



The lower console can contain a thick A4 folder.



Wide selection of refrigerators with capacities up to 100 litres and available with freezer.



The new open glove compartment includes a 1.5-litre bottle holder.

Rest, relax and sleep well



The symmetrical layout of the sleeping area is optimised to provide restful sleep and includes a comfortable ADR-compliant mattress.



The rotary switch controls the light selection and dimming.



Full L.E.D illumination both inside and outside the cabin.



The upper bunk can be used as a luggage compartment.



Two USB ports are located on the upper pockets of each wall.



Central bed module provides easy access to vehicle functions including lighting, heating, radio and doors. Features can also be controlled using the MYIVECO Easy Way App.

The right cab for every application



The IVECO S-WAY cab line up offers a choice of cabs to match your application: the **AS** sleeper cab, the **AT** sleeper cab with low or medium roof, and the **AD** short cab with low roof.

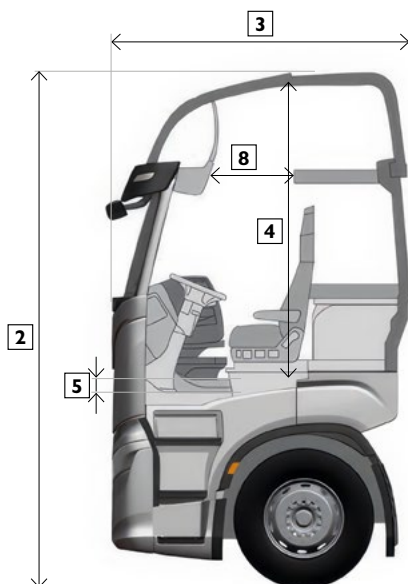

LEGEND

- 1 WIDTH
- 2 OVERALL HEIGHT
- 3 LENGTH
- 4 FLOOR TO ROOF CAB CENTRE
- 5 TUNNEL HEIGHT
- 6 PASSENGER USABLE SPACE
- 7 LOWER USABLE SPACE
- 8 UPPER USABLE SPACE

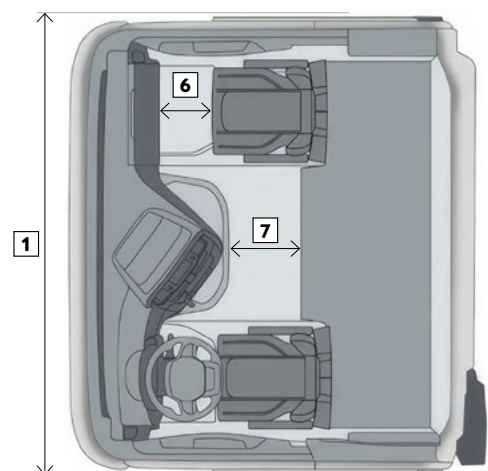



Overseas Models Shown

| | | 1 | 2 | 3 | 4 | 5 | 6 | 7 | 8 | | |
|-----------|-----------|------------|---------------------|---------------------|-------------------------------|--------------------|-----------------------------|-------------------------|-------------------------|---------------------|----------------|
| AS | Roof | Width (mm) | Overall Height (mm) | Length (mm) | Floor to Roof Cab Centre (mm) | Tunnel Height (mm) | Passenger Usable Space (mm) | Lower Usable Space (mm) | Upper Usable Space (mm) | Bunk ⁽²⁾ | Boarding Steps |
| | High | 2500 | 3800 ⁽¹⁾ | 2250 | 2150 | 95 | 430 | 500 | 785 | 1 ⁽²⁾ | 3 |
| | Low | 2500 | 3300 ⁽¹⁾ | 2250 | 1700 | 95 | 430 | 500 | - | 1 | |
| AT | Medium | 2300 | 3500 ⁽¹⁾ | 2150 | 1850 | 340 | 370 | 470 | 480 | 1 ⁽²⁾ | 3 |
| | Low | 2300 | 2900 ⁽¹⁾ | 2150 | 1250 | 340 | 370 | 470 | - | 1 | |
| | AD | Low | 2300 | 2900 ⁽¹⁾ | 1700 | 1250 | 340 | 370 | - | - | 0 |

Dimensions can vary according to the model.

Notes

⁽¹⁾Approximate measures; may change based on suspensions, assembly variables and approximations.

⁽²⁾Upper bed as option.





AS Cab





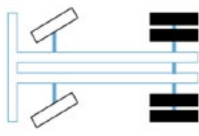
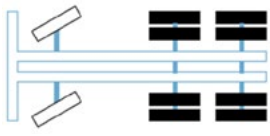

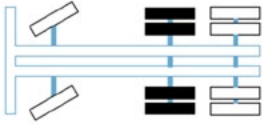
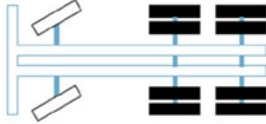
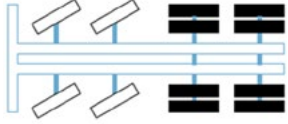

Lower bunk length 2100 mm, width 800 mm (700 mm rear seats), upper bunk length 2040 mm, width 600 mm (700 mm with Comfort Bunk).

AT Cab

Lower bunk length 1950 mm, width 540 mm, upper bunk length 1850 mm, width 680 mm.

Choose your S-WAY model

| | | Prime movers | | | |
|----------------------|-----------|--|---|---|---|
| | | 4x2 | | 6x4 | |
| IVECO S-WAY | |  | |  | |
| CAB ROOF | AS | - | - | - |  |
| | AT |  | - |  | - |
| | AD | - | - |  | - |
| ENGINE GEARBOX | Cursor 9 | - | - | - | - |
| | Cursor 11 | Automated | - | Automated | - |
| | Cursor 13 | - | - | - | Automated |
| VEHICLE SET-UP | ON/ ON+ | ON | - | ON | ON |
| REAR AXLE SUSPENSION | SR | Pneumatic Rear | | Pneumatic Rear | |
| CONNECTIVITY BOX | | Standard | | | |
| WHEELBASES (mm) | | 3,650 | | 3,200 – 3,300 – 3,500 | |

| | | Rigid | | | | | |
|-----------------------------|-----------|---|---|---|--|---|---|
| | | 6 x 2 | | 6 x 4 | | 8 x 4 (2+2) | |
| IVECO S-WAY | |  | |  | |  | |
| CAB ROOF | AS | - | - | - |  | - |  |
| | AT |  | - |  | - |  | - |
| | AD |  | - |  | - |  | - |
| ENGINE GEARBOX | Cursor 9 | Automated | - | - | - | - | - |
| | Cursor 11 | - | - | Automated | - | Automated | - |
| | Cursor 13 | - | - | - | Automated | - | Automated |
| VEHICLE SET-UP | ON/ ON+ | ON | - | ON/ ON+ | | ON | ON |
| REAR AXLE SUSPENSION | SR | Pneumatic Rear | | Pneumatic Rear | | Pneumatic Full | |
| CONNECTIVITY BOX | | Standard | | | | | |
| WHEELBASES (mm) | | 5,700 – 6,050 | | 3,500 – 3,800 – 4,500 – 5,100 – 5,700 | | 5,300 – 5,600 – 5,820 | |

